

# KATALOG

Ausgabe: 2016

# PEDDINGHAUS



Fritz Haas  
Werksvertretungen  
Robert-Bosch-Str. 6  
90513 Zirndorf



Tel: +49 (0)911 / 699097  
Fax: +49 (0)911 / 697487  
[info@haas-werksvertretungen.de](mailto:info@haas-werksvertretungen.de)

Wir sind gerne für Sie da. Sie erreichen uns

per Telefon: +49 (0)911 / 699097

per Fax: +49 (0)911 / 697487

per E-Mail: [info@haas-werksvertretungen.de](mailto:info@haas-werksvertretungen.de)

Öffnungszeiten: Mo - Do 7.45 - 16.30 Uhr  
Fr 7.45 - 14.30 Uhr

Termine außerhalb der Öffnungszeiten, nach Absprache, möglich.

Fritz Haas  
Werksvertretungen  
Robert-Bosch-Str. 6  
90513 Zirndorf

Tel: +49 (0)911 / 699097  
Fax: +49 (0)911 / 697487  
[info@haas-werksvertretungen.de](mailto:info@haas-werksvertretungen.de)

# Inhalt:

<b>Kapitel 1</b>	Stempel & Matrizen für motorisch betriebene Stanzen und Mehrstempelwerkzeuge
------------------	--

<b>Kapitel 2</b>	Stempel- / Matrizenreduzierungen Druckstücke
------------------	---

Fritz Haas  
Werksvertretungen  
Robert-Bosch-Str. 6  
90513 Zirndorf

Tel: +49 (0)911 / 699097  
Fax: +49 (0)911 / 697487  
[info@haas-werksvertretungen.de](mailto:info@haas-werksvertretungen.de)

# PEDDINGHAUS

Dieser Katalog zeigt – in klarer Gliederung – das komplette Peddinghaus-Programm über genormte Stempel und Matrizen für die rationelle Blech-, Flach- und Profilstahlbearbeitung. Alle hier aufgeführten Werkzeuge sind kurzfristig lieferbar.

Alle Werkzeuge dieses Kataloges sind für die Bearbeitung von Material bis zu einer Festigkeit von 600 N/mm<sup>2</sup> geeignet. Werkzeuge zur Bearbeitung von Material mit höherer Festigkeit werden auf Wunsch gesondert gefertigt.

Bei den in diesem Katalog aufgeführten Langlochwerkzeugen entspricht der Radius der halben Lochbreite. Falls erforderlich, abweichende Radien bitte angeben. Diese Werkzeuge werden in Sonderanfertigung hergestellt.

Für jedes Werkzeug bitte die komplette Artikel-Nummer angeben.

## Bestell-Beispiel:

Stempel 50556 4

Schnittform: Rund

10 Stück Abmessung: 15,0 mm

Artikel-Nummer: 5055641

Die Größe des zu stanzenden Loches wird durch die Abmessung des Stempels bestimmt. Die Stempel sind mit diesem Maß gekennzeichnet.

Die Öffnung der Matrize muss um das Schneidspiel (= 2x Schneidspalt) größer sein. Erfahrungsgemäß sollte das Schneidspiel ca. 10% der Materialstärke betragen. Die Kennzeichnung der Matrize gibt die tatsächliche Abmessung der Schneidöffnung (Öffnung in der Matrize) an.

## Bei der Festlegung des Schneidspiels empfehlen wir folgende Regeln:

Für runde und quadratische Schnittform:

Materialstärke:	mm	bis 4	> 4 bis 9	> 9 bis 14	> 14 bis 19	> 19 bis 24
Schneidspiel:	mm	0,2	0,7	1,2	1,7	2,2

Beispiel: Stempeldurchmesser: 20,0 mm  
Materialstärke: 12,0 mm  
Matrizenöffnung: 21,2 mm

=> Falls in der Bestellung keine Matrizenabmessungen oder Materialstärken mitgeteilt werden, so wird generell das Schneidspiel 0,7 mm geliefert.

Für Langlochschnittform:

Langlochwerkzeuge werden nach der Peddinghaus-Norm mit 0,2 mm und 0,7 mm Schneidspiel gefertigt.

Materialstärke:	mm	bis 6	> 6 bis 9
Schneidspiel:	mm	0,2	0,7

Beispiel: Langlochabmessung: 11,0 x 30,0 mm  
Materialstärke: 1 – 6 mm  
= Matrizenöffnung: 11,2 x 30,2 mm  
Materialstärke: 6 – 9 mm  
= Matrizenöffnung: 11,7 x 30,7 mm

=> Falls in der Bestellung keine Matrizenabmessungen oder Materialstärken mitgeteilt werden, so wird generell das Schneidspiel 0,7 mm geliefert.

**Fritz Haas**  
Werkvertretungen  
Robert-Bosch-Str. 6  
90513 Zirndorf

Tel: +49 (0)911 / 699097  
Fax: +49 (0)911 / 697487  
info@haas-werkvertretungen.de

# PEDDINGHAUS

Auf Wunsch werden die hier aufgeführten Stempel und Matrizen Typen als Sonderanfertigung in jeder gewünschten Schnittform hergestellt; z. B. Dreieck-, Rechteck-, Sechskant- sowie in anderen Schnittformen.

Selbstverständlich fertigt unser Werk alle Spezialstanzwerkzeuge nach Ihren Angaben (Zeichnung oder Muster).

Bitte beachten Sie beim Einsatz von unseren Stanzwerkzeugen auf folgende grundlegende Punkte:

- Achten Sie bitte auf einen gleichmäßigen Schneidspalt zwischen Stempel- und Matrizenöffnung.
- Die Matrize muss in der Halterung einen festen Sitz haben. Ebenfalls müssen Stempelhalter und Stempelfutter in ihren Halterungen sicher befestigt sein.
- Die Abstreifer / Niederhalter (siehe nachstehende Skizze) müssen gleichmäßig abstreifen und plan zur Matrizenoberfläche stehen.
- Um eine möglichst lange Lebensdauer der Werkzeuge zu erreichen, sollten die Stempel beim Stanzen öfter mit Öl bestrichen werden.
- Beim Einsetzen von Langloch, Vierkant sowie in anderen Spezial-Schnittformen muss der mitgelieferte Verdrehsicherungsstift eingesetzt werden.
- Um eine Überlastung Ihrer Maschine zu vermeiden, empfehlen wir, den beim Stanzen der Löcher entstehenden Stanzdruck nach folgender Formel zu überprüfen. Die max. Stanzkraft ist aus dem Leistungsschild an Ihrer Maschine ersichtlich.

Stanzkraft (F) =

(Umfang Stempel ( $\pi \times d$ ) x Materialstärke (s) x Zugfestigkeit (Rm) x [Faktor 0,8]) : (9810 ( Umrechnung Nm in t))

Rm = Zugfestigkeit (N/mm<sup>2</sup>):  
Edelstahl 1.4301 = 720 N/mm<sup>2</sup>  
Stahl St 37 = 420 N/mm<sup>2</sup>  
Aluminium AlMg3 = 220 N/mm<sup>2</sup>

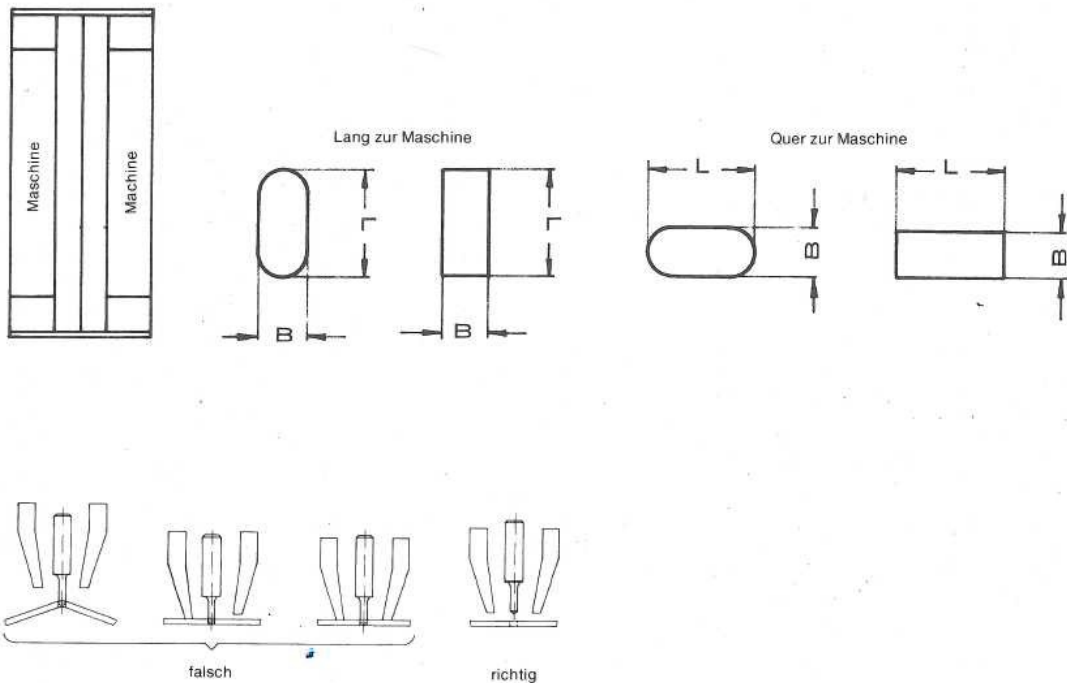

Fritz Haas  
Werksvertretungen  
Robert-Bosch-Str. 6  
90513 Zirndorf

Tel: +49 (0)911 / 699097  
Fax: +49 (0)911 / 697487  
info@haas-werksvertretungen.de

# PEDDINGHAUS

## Maschinen- / Werkzeugübersicht

### Serie A (entspricht Peddinghaus Serie "ROT")

#### Für ältere Modelle:

Peddicat 360 - 361  
Peddiworker 400 – 500 – 600 – 800  
Peddimaster 450M – 28/40 – 40/60 – 60/80 – 60/100 – 80/110  
Hydraulic 28 – 40 – 60N – 300 – 400 – 500 – 600  
210 Super/Standard 11 – 13  
Forax 15 – 25 – 45 – 65 – 150 – 250 – 450  
Stanzfix  
225 B/11 – 13 – 45 – 60  
225 H/11 – 13

### Serie B (entspricht Peddinghaus Serie "GRÜN")

#### Für Modelle der heutigen Generation:

Peddicat No. 1  
Peddiworker No. 1  
Hydraulic 280 – 502 – 1001

#### Für ältere Modelle:

Peddicat 361 – 380 – 500  
Peddiworker 501 – 502 – 801 – 802 – 1000 G  
Peddimaster 100/160 – 110/170 – 800/1100 – 1100/1700  
Peddimax 600 – 601 – 800 – 801 – 110/140 – 1002  
Hydraulic 100 – 301 – 501 – 800 – 1000  
210 Super 16 – 20 – 210 Standard 16  
Forax 80 – 100 – 1000  
225 B/16 – 20 – 80 – 100  
225 H/15 – 20

### Serie C (entspricht Peddinghaus Serie "BLAU")

Hydraulic 1000N / 1400N

Für Sonder-Stanzvorrichtungen bis 39 – 58 – 65 – 90mm Ø  
Zu allen Modellen auf den Seiten 1 + 8 und für Peddimax No. 1

#### Für ältere Modelle:

225 B/25 – 130  
Hydraulic – 140  
210 Super 25

Fritz Haas  
Werksvertretungen  
Robert-Bosch-Str. 6  
90513 Zirndorf

Tel: +49 (0)911 / 699097  
Fax: +49 (0)911 / 697487  
info@haas-werksvertretungen.de

## Kapitel 1

Stempel & Matrizen für motorisch betriebene  
Stanzen und Mehrstempelwerkzeuge

Fritz Haas  
Werksvertretungen  
Robert-Bosch-Str. 6  
90513 Zirndorf

Tel: +49 (0)911 / 699097  
Fax: +49 (0)911 / 697487  
[info@haas-werksvertretungen.de](mailto:info@haas-werksvertretungen.de)

# PEDDINGHAUS

## Rundstempel Nr. 1

Code 50556 1 1

### Serie A

Artikelnummer	Abmessung
5055611008	3.0 mm
5055611011	3.5 mm
5055611013	4.0 mm
5055611015	4.5 mm
5055611017	5.0 mm
5055611019	5.5 mm
5055611022	6.0 mm
5055611024	6.5 mm
5055611026	7.0 mm
5055611028	7.5 mm
5055611031	8.0 mm
5055611033	8.5 mm
5055611035	9.0 mm
5055611037	9.5 mm
5055611039	10.0 mm
5055611042	10.5 mm
5055611044	11.0 mm
5055611046	11.5 mm
5055611048	12.0 mm
5055611051	12.5 mm
5055611053	13.0 mm
5055611055	13.5 mm
5055611057	14.0 mm
5055611059	14.5 mm

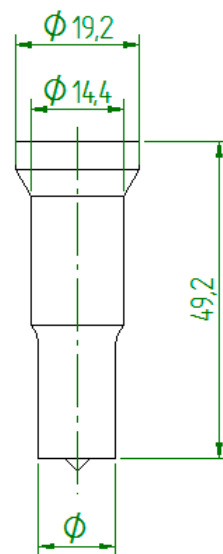

Fritz Haas  
Werkvertretungen  
Robert-Bosch-Str. 6  
90513 Zirndorf

Tel: +49 (0)911 / 699097  
Fax: +49 (0)911 / 697487  
info@haas-werkvertretungen.de



# PEDDINGHAUS

## Rundstempel Nr. 4

Code 50556 4 1

### Serie A

Artikelnummer	Abmessung
5055641008	3.0 mm
5055641011	3.5 mm
5055641013	4.0 mm
5055641015	4.5 mm
5055641017	5.0 mm
5055641019	5.5 mm
5055641022	6.0 mm
5055641024	6.5 mm
5055641026	7.0 mm
5055641028	7.5 mm
5055641031	8.0 mm
5055641033	8.5 mm
5055641035	9.0 mm
5055641037	9.5 mm
5055641039	10.0 mm
5055641042	10.5 mm
5055641044	11.0 mm
5055641046	11.5 mm
5055641048	12.0 mm
5055641051	12.5 mm
5055641053	13.0 mm
5055641055	13.5 mm
5055641057	14.0 mm
5055641059	14.5 mm
5055641062	15.0 mm
5055641064	15.5 mm
5055641066	16.0 mm
5055641068	16.5 mm
5055641071	17.0 mm
5055641073	17.5 mm
5055641075	18.0 mm
5055641077	18.5 mm
5055641079	19.0 mm
5055641082	19.5 mm
5055641084	20.0 mm
5055641086	20.5 mm
5055641088	21.0 mm
5055641091	21.5 mm
5055641093	22.0 mm
5055641095	22.5 mm
5055641097	23.0 mm
5055641099	23.5 mm
5055641102	24.0 mm
5055641104	24.5 mm
5055641106	25.0 mm
5055641108	25.5 mm
5055641111	26.0 mm
5055641113*	26.5 mm*
5055641115*	27.0 mm*
5055641119*	28.0 mm*
5055641124*	29.0 mm*
5055641128*	30.0 mm*

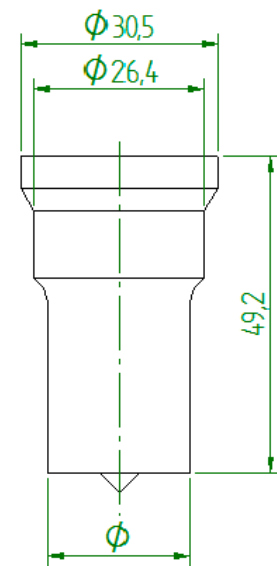

\* Aufnahme nur mit Schnellspanneinsatz  $\Phi 30,2$  mm möglich

Fritz Haas  
Werksvertretungen  
Robert-Bosch-Str. 6  
90513 Zirndorf

Tel: +49 (0)911 / 699097  
Fax: +49 (0)911 / 697487  
info@haas-werksvertretungen.de

# PEDDINGHAUS

## Vierkantstempel Nr. 4

Code 50556 4 2

### Serie A

Artikelnummer	Abmessung
5055642112	4.0 mm
5055642116	5.0 mm
5055642122	6.0 mm
5055642126	7.0 mm
5055642132	8.0 mm
5055642136	9.0 mm
5055642142	10.0 mm
5055642146	11.0 mm
5055642152	12.0 mm
5055642156	13.0 mm
5055642162	14.0 mm
5055642166	15.0 mm
5055642172	16.0 mm
5055642176	17.0 mm
5055642182	18.0 mm
5055642186	19.0 mm
5055642192*	20.0 mm*
5055642196*	21.0 mm*

\* Aufnahme nur mit Schnellspanneinsatz  $\varnothing 30,2$  mm möglich

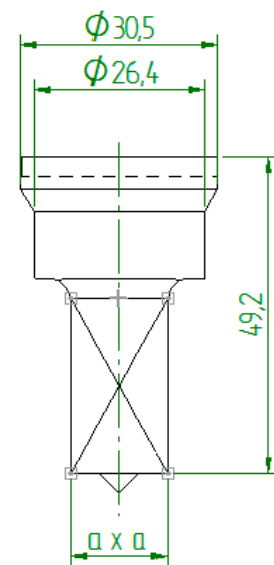

Fritz Haas  
Werksvertretungen  
Robert-Bosch-Str. 6  
90513 Zirndorf

Tel: +49 (0)911 / 699097  
Fax: +49 (0)911 / 697487  
info@haas-werksvertretungen.de

# PEDDINGHAUS

## Langlochstempel Nr. 4

Code 50556 4 3

### Serie A

Artikelnummer	Abmessung
5055643001	5.0 x 10.0 mm
5055643003	5.0 x 14.0 mm
5055643005	5.5 x 10.0 mm
5055643007	5.5 x 14.0 mm
5055643009	5.5 x 19.0 mm
5055643010	5.5 x 25.0 mm
5055643011	6.5 x 12.0 mm
5055643013	6.5 x 18.0 mm
5055643015	6.5 x 26.0 mm
5055643019	7.5 x 14.0 mm
5055643021	7.5 x 21.0 mm
5055643023	7.5 x 26.0 mm
5055643025	8.0 x 16.0 mm
5055643027	9.0 x 14.0 mm
5055643029	9.0 x 18.0 mm
5055643031	9.0 x 26.0 mm
5055643035	10.0 x 14.0 mm
5055643037	10.0 x 20.0 mm
5055643039	10.0 x 26.0 mm
5055643043	11.0 x 22.0 mm
5055643045	11.0 x 26.0 mm
5055643049	12.0 x 24.0 mm
5055643053	13.0 x 26.0 mm
5055643057	14.0 x 26.0 mm
5055643061	16.0 x 26.0 mm
5055643063	17.0 x 26.0 mm
5055643065	18.0 x 26.0 mm
5055643073	19.0 x 26.0 mm
5055643047*	11.0 x 30.0 mm*
5055643051*	12.0 x 30.0 mm*
5055643055*	13.0 x 30.0 mm*
5055643059*	14.0 x 30.0 mm*
5055643068*	18.0 x 30.0 mm*
5055643093*	22.0 x 30.0 mm*

\* Aufnahme nur mit Schnellspanneinsatz  $\varnothing 30,2$  mm möglich

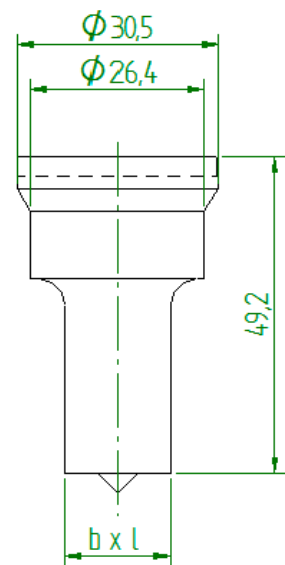

Fritz Haas  
Werksvertretungen  
Robert-Bosch-Str. 6  
90513 Zirndorf

Tel: +49 (0)911 / 699097  
Fax: +49 (0)911 / 697487  
info@haas-werksvertretungen.de

# PEDDINGHAUS

## Rundstempel Nr. 2

Code 50556 2 1

### Serie B

Artikelnummer	Abmessung
5055621008	3.0 mm
5055621011	3.5 mm
5055621013	4.0 mm
5055621015	4.5 mm
5055621017	5.0 mm
5055621019	5.5 mm
5055621022	6.0 mm
5055621024	6.5 mm
5055621026	7.0 mm
5055621028	7.5 mm
5055621031	8.0 mm
5055621033	8.5 mm
5055621035	9.0 mm
5055621037	9.5 mm
5055621039	10.0 mm
5055621042	10.5 mm
5055621044	11.0 mm
5055621046	11.5 mm
5055621048	12.0 mm
5055621051	12.5 mm
5055621053	13.0 mm
5055621055	13.5 mm
5055621057	14.0 mm
5055621059	14.5 mm
5055621062	15.0 mm
5055621064	15.5 mm
5055621066	16.0 mm
5055621068	16.5 mm
5055621071	17.0 mm
5055621073	17.5 mm
5055621075	18.0 mm
5055621077	18.5 mm
5055621079	19,0 mm

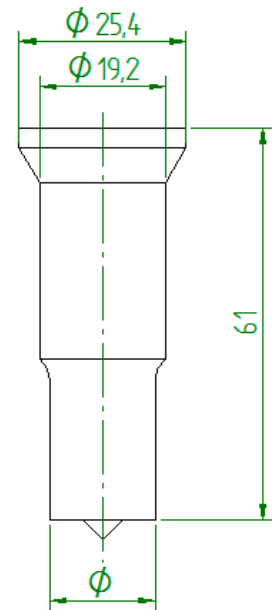

Fritz Haas  
Werksvertretungen  
Robert-Bosch-Str. 6  
90513 Zirndorf

Tel: +49 (0)911 / 699097  
Fax: +49 (0)911 / 697487  
info@haas-werksvertretungen.de

# PEDDINGHAUS

## Vierkantstempel Nr. 2

Code 50556 2 2

### Serie B

Artikelnummer	Abmessung
5055622112	4.0 mm
5055622116	5.0 mm
5055622122	6.0 mm
5055622126	7.0 mm
5055622132	8.0 mm
5055622136	9.0 mm
5055622142	10.0 mm
5055622146	11.0 mm
5055622152	12.0 mm
5055622156	13.0 mm

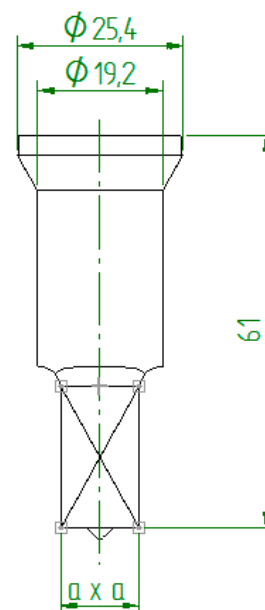

Fritz Haas  
Werksvertretungen  
Robert-Bosch-Str. 6  
90513 Zirndorf

Tel: +49 (0)911 / 699097  
Fax: +49 (0)911 / 697487  
info@haas-werksvertretungen.de

# PEDDINGHAUS

## Langlochstempel Nr. 2

Code 50556 2 3

### Serie B

Artikelnummer	Abmessung
5055623001	5.0 x 10.0 mm
5055623003	5.0 x 14.0 mm
5055623005	5.5 x 10.0 mm
5055623007	5.5 x 14.0 mm
5055623009	5.5 x 19.0 mm
5055623011	6.5 x 12.0 mm
5055623013	6.5 x 18.0 mm
5055623019	7.5 x 14.0 mm
5055623027	9.0 x 14.0 mm
5055623029	9.0 x 18.0 mm
5055623035	10.0 x 14.0 mm

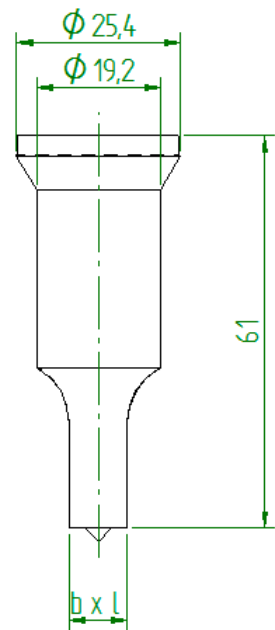

Fritz Haas  
Werksvertretungen  
Robert-Bosch-Str. 6  
90513 Zirndorf

Tel: +49 (0)911 / 699097  
Fax: +49 (0)911 / 697487  
info@haas-werksvertretungen.de

# PEDDINGHAUS

## Rundstempel Nr. 5

Code 50556 5 1

### Serie B

Artikelnummer	Abmessung	Artikelnummer	Abmessung
5055651008	3.0 mm	5055651119	28.0 mm
5055651011	3.5 mm	5055651122	28.5 mm
5055651013	4.0 mm	5055651124	29.0 mm
5055651015	4.5 mm	5055651126	29.5 mm
5055651017	5.0 mm	5055651128	30.0 mm
5055651019	5.5 mm	5055651131	30.5 mm
5055651022	6.0 mm	5055651133	31.0 mm
5055651024	6.5 mm	5055651135	31.5 mm
5055651026	7.0 mm	5055651137	32.0 mm
5055651028	7.5 mm		
5055651031	8.0 mm		
5055651033	8.5 mm		
5055651035	9.0 mm		
5055651037	9.5 mm		
5055651039	10.0 mm		
5055651042	10.5 mm		
5055651044	11.0 mm		
5055651046	11.5 mm		
5055651048	12.0 mm		
5055651051	12.5 mm		
5055651053	13.0 mm		
5055651055	13.5 mm		
5055651057	14.0 mm		
5055651059	14.5 mm		
5055651062	15.0 mm		
5055651064	15.5 mm		
5055651066	16.0 mm		
5055651068	16.5 mm		
5055651071	17.0 mm		
5055651073	17.5 mm		
5055651075	18.0 mm		
5055651077	18.5 mm		
5055651079	19.0 mm		
5055651082	19.5 mm		
5055651084	20.0 mm		
5055651086	20.5 mm		
5055651088	21.0 mm		
5055651091	21.5 mm		
5055651093	22.0 mm		
5055651095	22.5 mm		
5055651097	23.0 mm		
5055651099	23.5 mm		
5055651102	24.0 mm		
5055651104	24.5 mm		
5055651106	25.0 mm		
5055651108	25.5 mm		
5055651111	26.0 mm		
5055651113	26.5 mm		
5055651115	27.0 mm		
5055651117	27.5 mm		

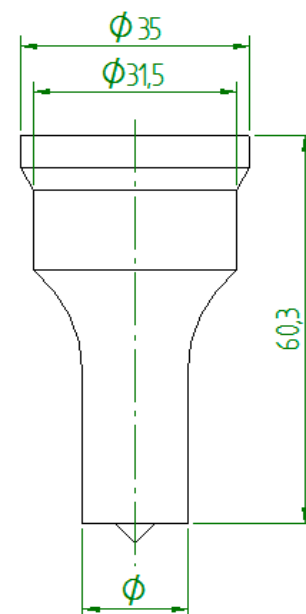

Fritz Haas  
Werksvertretungen  
Robert-Bosch-Str. 6  
90513 Zirndorf

Tel: +49 (0)911 / 699097  
Fax: +49 (0)911 / 697487  
info@haas-werksvertretungen.de

# PEDDINGHAUS

## Vierkantstempel Nr. 5

Code 50556 5 2

### Serie B

Artikelnummer	Abmessung
5055652112	4.0 mm
5055652116	5.0 mm
5055652122	6.0 mm
5055652126	7.0 mm
5055652132	8.0 mm
5055652136	9.0 mm
5055652142	10.0 mm
5055652146	11.0 mm
5055652152	12.0 mm
5055652156	13.0 mm
5055652162	14.0 mm
5055652166	15.0 mm
5055652172	16.0 mm
5055652176	17.0 mm
5055652182	18.0 mm
5055652186	19.0 mm
5055652192	20.0 mm
5055652196	21.0 mm
5055652202	22.0 mm

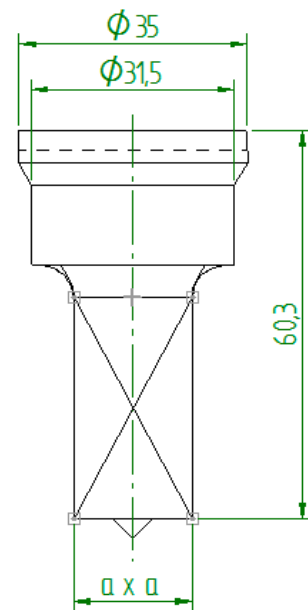

Fritz Haas  
Werksvertretungen  
Robert-Bosch-Str. 6  
90513 Zirndorf

Tel: +49 (0)911 / 699097  
Fax: +49 (0)911 / 697487  
info@haas-werksvertretungen.de



# PEDDINGHAUS

## Langlochstempel Nr. 5

Code 50556 5 3

### Serie B

Artikelnummer	Abmessung
5055653001	5.0 x 10.0 mm
5055653003	5.0 x 14.0 mm
5055653005	5.5 x 10.0 mm
5055653007	5.5 x 14.0 mm
5055653009	5.5 x 19.0 mm
5055653010	5.5 x 25.0 mm
5055653011	6.5 x 12.0 mm
5055653013	6.5 x 18.0 mm
5055653015	6.5 x 26.0 mm
5055653017	6.5 x 30.0 mm
5055653019	7.5 x 14.0 mm
5055653021	7.5 x 21.0 mm
5055653023	7.5 x 26.0 mm
5055653025	7.5 x 30.0 mm
5055653027	9.0 x 14.0 mm
5055653029	9.0 x 18.0 mm
5055653031	9.0 x 26.0 mm
5055653033	9.0 x 30.0 mm
5055653035	10.0 x 14.0 mm
5055653037	10.0 x 20.0 mm
5055653039	10.0 x 26.0 mm
5055653041	10.0 x 30.0 mm
5055653043	11.0 x 22.0 mm
5055653045	11.0 x 26.0 mm
5055653047	11.0 x 30.0 mm
5055653049	12.0 x 24.0 mm
5055653051	12.0 x 30.0 mm
5055653053	13.0 x 26.0 mm
5055653055	13.0 x 30.0 mm
5055653057	14.0 x 26.0 mm
5055653059	14.0 x 28.0 mm
5055653060	14.0 x 31.0 mm
5055653061	16.0 x 26.0 mm
5055653063	16.0 x 31.0 mm
5055653065	18.0 x 26.0 mm
5055653067	18.0 x 31.0 mm
5055653069	20.0 x 31.0 mm
5055653071	22.0 x 31.0 mm

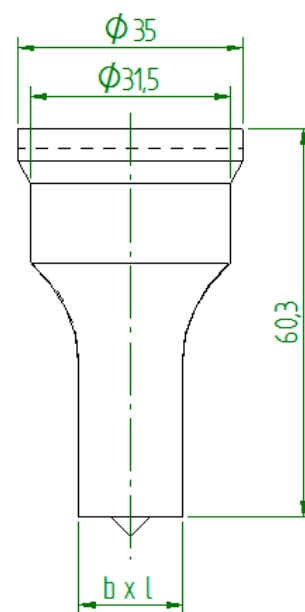

Fritz Haas  
Werksvertretungen  
Robert-Bosch-Str. 6  
90513 Zirndorf

Tel: +49 (0)911 / 699097  
Fax: +49 (0)911 / 697487  
info@haas-werksvertretungen.de

# PEDDINGHAUS

## Rundstempel Nr. 3

Code 50556 3 1

### Serie C

Artikelnummer	Abmessung
5055631008	3.0 mm
5055631011	3.5 mm
5055631013	4.0 mm
5055631015	4.5 mm
5055631017	5.0 mm
5055631019	5.5 mm
5055631022	6.0 mm
5055631024	6.5 mm
5055631026	7.0 mm
5055631028	7.5 mm
5055631031	8.0 mm
5055631033	8.5 mm
5055631035	9.0 mm
5055631037	9.5 mm
5055631039	10.0 mm
5055631042	10.5 mm
5055631044	11.0 mm
5055631046	11.5 mm
5055631048	12.0 mm
5055631051	12.5 mm
5055631053	13.0 mm
5055631055	13.5 mm
5055631057	14.0 mm
5055631059	14.5 mm
5055631062	15.0 mm
5055631064	15.5 mm
5055631066	16.0 mm
5055631068	16.5 mm
5055631071	17.0 mm
5055631073	17.5 mm
5055631075	18.0 mm
5055631077	18.5 mm
5055631079	19.0 mm
5055631082	19.5 mm
5055631084	20.0 mm
5055631086	20.5 mm
5055631088	21.0 mm
5055631091	21.5 mm
5055631093	22.0 mm
5055631095	22.5 mm
5055631097	23.0 mm
5055631099	23.5 mm
5055631102	24.0 mm
5055631104	24.5 mm
5055631106	25.0 mm
5055631108	25.5 mm
5055631111	26.0 mm
5055631113	26.5 mm
5055631115	27.0 mm

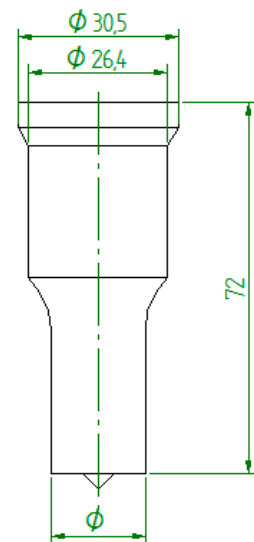

Fritz Haas  
Werksvertretungen  
Robert-Bosch-Str. 6  
90513 Zirndorf

Tel: +49 (0)911 / 699097  
Fax: +49 (0)911 / 697487  
info@haas-werksvertretungen.de

# PEDDINGHAUS

## Vierkantstempel Nr. 3

Code 50556 3 2

### Serie C

Artikelnummer	Abmessung
5055632112	4.0 mm
5055632116	5.0 mm
5055632122	6.0 mm
5055632126	7.0 mm
5055632132	8.0 mm
5055632136	9.0 mm
5055632142	10.0 mm
5055632146	11.0 mm
5055632152	12.0 mm
5055632156	13.0 mm
5055632162	14.0 mm
5055632166	15.0 mm
5055632172	16.0 mm
5055632176	17.0 mm
5055632182	18.0 mm

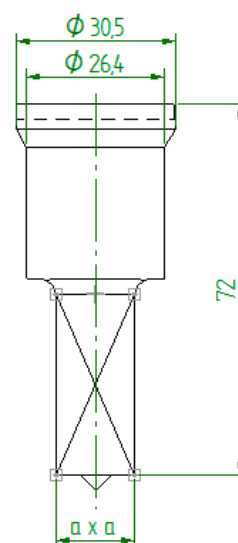

Fritz Haas  
Werksvertretungen  
Robert-Bosch-Str. 6  
90513 Zirndorf

Tel: +49 (0)911 / 699097  
Fax: +49 (0)911 / 697487  
info@haas-werksvertretungen.de

# PEDDINGHAUS

## Langlochstempel Nr. 3

Code 50556 3 3

### Serie C

Artikelnummer	Abmessung
5055633001	5.0 x 10.0 mm
5055633003	5.0 x 14.0 mm
5055633005	5.5 x 10.0 mm
5055633007	5.5 x 14.0 mm
5055633009	5.5 x 19.0 mm
5055633010	5.5 x 25.0 mm
5055633011	6.5 x 12.0 mm
5055633013	6.5 x 18.0 mm
5055633015	6.5 x 26.0 mm
5055633019	7.5 x 14.0 mm
5055633021	7.5 x 21.0 mm
5055633023	7.5 x 26.0 mm
5055633027	9.0 x 14.0 mm
5055633029	9.0 x 18.0 mm
5055633031	9.0 x 26.0 mm
5055633035	10.0 x 14.0 mm
5055633037	10.0 x 20.0 mm
5055633039	10.0 x 26.0 mm
5055633043	11.0 x 22.0 mm
5055633045	11.0 x 26.0 mm
5055633049	12.0 x 24.0 mm
5055633053	13.0 x 26.0 mm
5055633057	14.0 x 26.0 mm
5055633061	16.0 x 26.0 mm
5055633065	18.0 x 26.0 mm

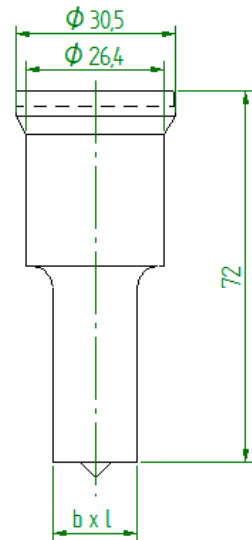

Fritz Haas  
Werkvertretungen  
Robert-Bosch-Str. 6  
90513 Zirndorf

Tel: +49 (0)911 / 699097  
Fax: +49 (0)911 / 697487  
info@haas-werkvertretungen.de

# PEDDINGHAUS

## Rundstempel Nr. 6

Code 50556 6 1

### Serie C

Artikelnummer	Abmessung
5055661086	20.5 mm
5055661088	21.0 mm
5055661091	21.5 mm
5055661093	22.0 mm
5055661095	22.5 mm
5055661097	23.0 mm
5055661099	23.5 mm
5055661102	24.0 mm
5055661104	24.5 mm
5055661106	25.0 mm
5055661108	25.5 mm
5055661111	26.0 mm
5055661113	26.5 mm
5055661115	27.0 mm
5055661117	27.5 mm
5055661119	28.0 mm
5055661122	28.5 mm
5055661124	29.0 mm
5055661126	29.5 mm
5055661128	30.0 mm
5055661131	30.5 mm
5055661133	31.0 mm
5055661135	31.5 mm
5055661137	32.0 mm
5055661139	32.5 mm
5055661142	33.0 mm
5055661144	33.5 mm
5055661146	34.0 mm
5055661148	34.5 mm
5055661151	35.0 mm
5055661153	35.5 mm
5055661155	36.0 mm
5055661157	36.5 mm
5055661159	37.0 mm
5055661162	37.5 mm
5055661164	38.0 mm
5055661166	38.5 mm
5055661168	39.0 mm
5055661171	39.5 mm
5055661173	40.0 mm

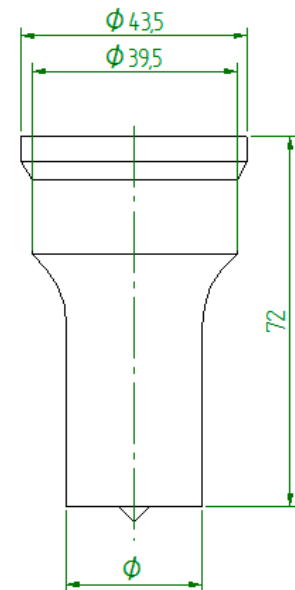

Fritz Haas  
Werksvertretungen  
Robert-Bosch-Str. 6  
90513 Zirndorf

Tel: +49 (0)911 / 699097  
Fax: +49 (0)911 / 697487  
info@haas-werksvertretungen.de

# PEDDINGHAUS

## Vierkantstempel Nr. 6

Code 50556 6 2

### Serie C

Artikelnummer	Abmessung
5055662186	19.0 mm
5055662192	20.0 mm
5055662196	21.0 mm
5055662202	22.0 mm
5055662206	23.0 mm
5055662212	24.0 mm
5055662216	25.0 mm
5055662222	26.0 mm
5055662226	27.0 mm
5055662232	28.0 mm

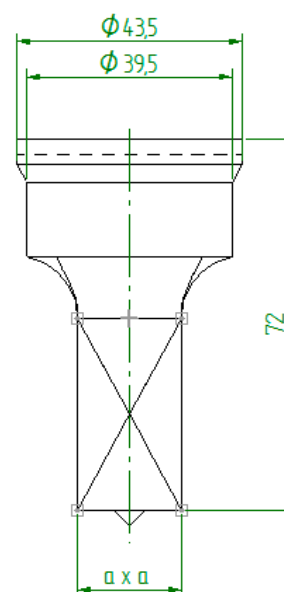

Fritz Haas  
Werksvertretungen  
Robert-Bosch-Str. 6  
90513 Zirndorf

Tel: +49 (0)911 / 699097  
Fax: +49 (0)911 / 697487  
info@haas-werksvertretungen.de

# PEDDINGHAUS

## Langlochstempel Nr. 6

Code 50556 6 3

### Serie C

Artikelnummer	Abmessung
5055663010	5.5 x 25.0 mm
5055663015	6.5 x 26.0 mm
5055663017	6.5 x 30.0 mm
5055663023	7.5 x 26.0 mm
5055663025	7.5 x 30.0 mm
5055663031	9.0 x 26.0 mm
5055663033	9.0 x 30.0 mm
5055663039	10.0 x 26.0 mm
5055663041	10.0 x 30.0 mm
5055663045	11.0 x 26.0 mm
5055663047	11.0 x 30.0 mm
5055663049	12.0 x 24.0 mm
5055663051	12.0 x 30.0 mm
5055663052	12.0 x 35.0 mm
5055663053	13.0 x 26.0 mm
5055663055	13.0 x 30.0 mm
5055663056	13.0 x 35.0 mm
5055663057	14.0 x 26.0 mm
5055663059	14.0 x 28.0 mm
5055663060	14.0 x 35.0 mm
5055663061	16.0 x 26.0 mm
5055663063	16.0 x 31.0 mm
5055663065	18.0 x 26.0 mm
5055663067	18.0 x 31.0 mm
5055663068	18.0 x 36.0 mm
5055663069	20.0 x 31.0 mm
5055663071	22.0 x 31.0 mm

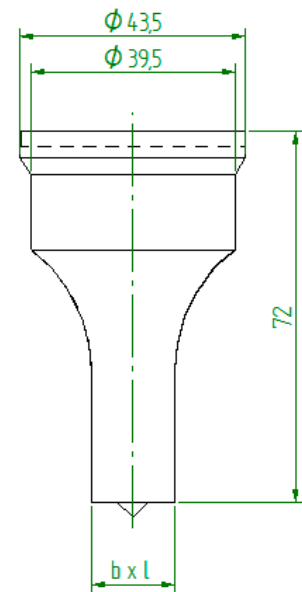

Fritz Haas  
Werksvertretungen  
Robert-Bosch-Str. 6  
90513 Zirndorf

Tel: +49 (0)911 / 699097  
Fax: +49 (0)911 / 697487  
info@haas-werksvertretungen.de

# PEDDINGHAUS

## Rundstempel Nr. 7

Code 50556 7 1

### Serie C

Artikelnummer	Abmessung
5055671173	40.0 mm
5055671177	41.0 mm
5055671182	42.0 mm
5055671186	43.0 mm
5055671191	44.0 mm
5055671195	45.0 mm
5055671199	46.0 mm
5055671204	47.0 mm
5055671208	48.0 mm
5055671213	49.0 mm
5055671217	50.0 mm
5055671222	51.0 mm
5055671226	52.0 mm
5055671231	53.0 mm
5055671235	54.0 mm
5055671239	55.0 mm
5055671244	56.0 mm
5055671248	57.0 mm
5055671253	58.0 mm

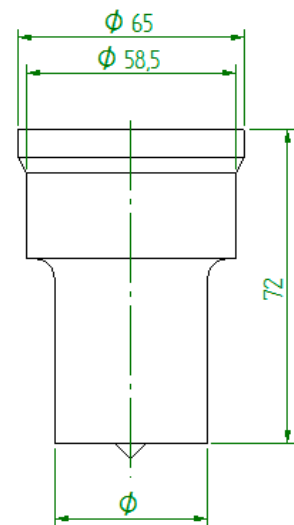

Fritz Haas  
Werksvertretungen  
Robert-Bosch-Str. 6  
90513 Zirndorf

Tel: +49 (0)911 / 699097  
Fax: +49 (0)911 / 697487  
info@haas-werksvertretungen.de



# PEDDINGHAUS

## Vierkantstempel Nr. 7

Code 50556 7 2

### Serie C

Artikelnummer	Abmessung
5055672242	30.0 mm
5055672266	35.0 mm
5055672303	40.0 mm

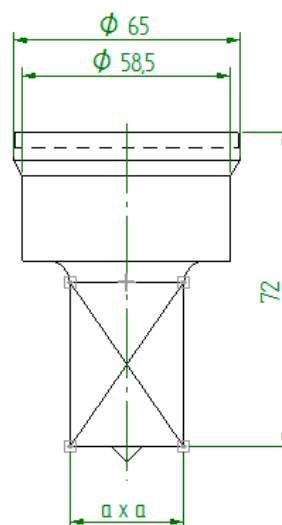

Fritz Haas  
Werksvertretungen  
Robert-Bosch-Str. 6  
90513 Zirndorf

Tel: +49 (0)911 / 699097  
Fax: +49 (0)911 / 697487  
info@haas-werksvertretungen.de

# PEDDINGHAUS

## Langlochstempel Nr. 7

Code 50556 7 3

### Serie C

Artikelnummer	Abmessung
5055673171	11.0 x 40.0 mm
5055673173	12.0 x 40.0 mm
5055673175	13.0 x 40.0 mm
5055673177	14.0 x 40.0 mm
5055673179	16.0 x 40.0 mm
5055673181	16.0 x 55.0 mm
5055673183	18.0 x 40.0 mm
5055673185	18.0 x 55.0 mm
5055673187	20.0 x 40.0 mm
5055673189	20.0 x 55.0 mm
5055673191	22.0 x 40.0 mm
5055673192	22.0 x 44.0 mm
5055673193	22.0 x 55.0 mm

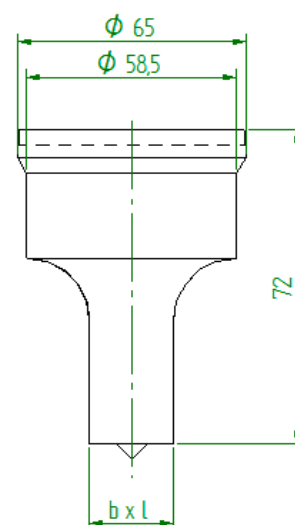

Fritz Haas  
Werksvertretungen  
Robert-Bosch-Str. 6  
90513 Zirndorf

Tel: +49 (0)911 / 699097  
Fax: +49 (0)911 / 697487  
info@haas-werksvertretungen.de

# PEDDINGHAUS

## Rundstempel Nr. 11

Code 50556

### Serie C

Artikelnummer	Abmessung
5055684262	60.0 mm
5055684283	60.0 mm
5055684285	65.0 mm
5055684311	70.0 mm
5055684333	75.0 mm
5055684355	80.0 mm
5055684377	85.0 mm
5055684399	90.0 mm

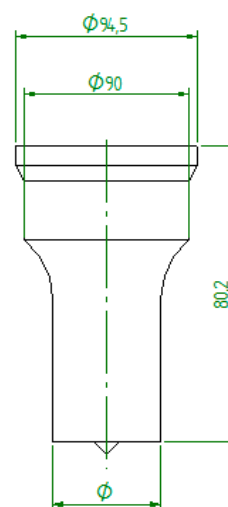

Fritz Haas  
Werksvertretungen  
Robert-Bosch-Str. 6  
90513 Zirndorf

Tel: +49 (0)911 / 699097  
Fax: +49 (0)911 / 697487  
info@haas-werksvertretungen.de

# PEDDINGHAUS

## Rundmatrize Nr. 2

### Code 50673 2 1

#### Serie A

Artikelnummer	Abmessung	Artikelnummer	Abmessung
5067321009	3.2 mm	5067321118	27.7 mm
5067321012	3.7 mm	5067321121	28.2 mm
5067321014	4.2 mm	5067321123	28.7 mm
5067321016	4.7 mm	5067321125	29.2 mm
5067321018	5.2 mm	5067321127	29.7 mm
5067321021	5.7 mm	5067321129	30.2 mm
5067321023	6.2 mm	5067321132	30.7 mm
5067321025	6.7 mm	5067321135	31.2 mm
5067321027	7.2 mm		
5067321029	7.7 mm		
5067321032	8.2 mm		
5067321034	8.7 mm		
5067321036	9.2 mm		
5067321038	9.7 mm		
5067321041	10.2 mm		
5067321043	10.7 mm		
5067321045	11.2 mm		
5067321047	11.7 mm		
5067321049	12.2 mm		
5067321052	12.7 mm		
5067321054	13.2 mm		
5067321056	13.7 mm		
5067321058	14.2 mm		
5067321061	14.7 mm		
5067321063	15.2 mm		
5067321065	15.7 mm		
5067321067	16.2 mm		
5067321069	16.7 mm		
5067321072	17.2 mm		
5067321074	17.7 mm		
5067321076	18.2 mm		
5067321078	18.7 mm		
5067321081	19.2 mm		
5067321083	19.7 mm		
5067321085	20.2 mm		
5067321087	20.7 mm		
5067321089	21.2 mm		
5067321092	21.7 mm		
5067321094	22.2 mm		
5067321096	22.7 mm		
5067321098	23.2 mm		
5067321101	23.7 mm		
5067321103	24.2 mm		
5067321105	24.7 mm		
5067321107	25.2 mm		
5067321109	25.7 mm		
5067321112	26.2 mm		
5067321114	26.7 mm		
5067321116	27.2 mm		

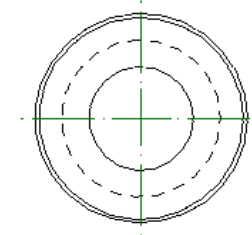
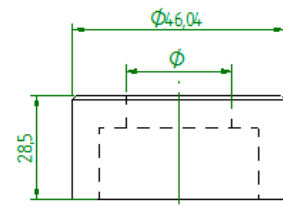

Fritz Haas  
Werksvertretungen  
Robert-Bosch-Str. 6  
90513 Zirndorf

Tel: +49 (0)911 / 699097  
Fax: +49 (0)911 / 697487  
info@haas-werksvertretungen.de

# PEDDINGHAUS

## Vierkantmatrize Nr. 2

Code 50673 2 2

### Serie A

Artikelnummer	Abmessung
5067322113	4.2 mm
5067322117	5.2 mm
5067322123	6.2 mm
5067322125	6.7 mm
5067322127	7.2 mm
5067322131	7.7 mm
5067322133	8.2 mm
5067322135	8.7 mm
5067322137	9.2 mm
5067322141	9.7 mm
5067322143	10.2 mm
5067322145	10.7 mm
5067322147	11.2 mm
5067322151	11.7 mm
5067322153	12.2 mm
5067322155	12.7 mm
5067322157	13.2 mm
5067322161	13.7 mm
5067322163	14.2 mm
5067322165	14.7 mm
5067322167	15.2 mm
5067322171	15.7 mm
5067322173	16.2 mm
5067322175	16.7 mm
5067322177	17.2 mm
5067322181	17.7 mm
5067322183	18.2 mm
5067322185	18.7 mm
5067322187	19.2 mm
5067322191	19.7 mm
5067322193	20.2 mm
5067322195	20.7 mm
5067322197	21.2 mm
5067322201	21.7 mm

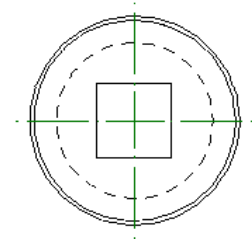
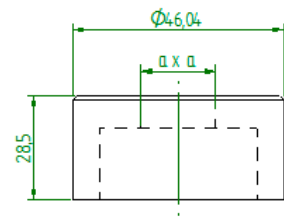
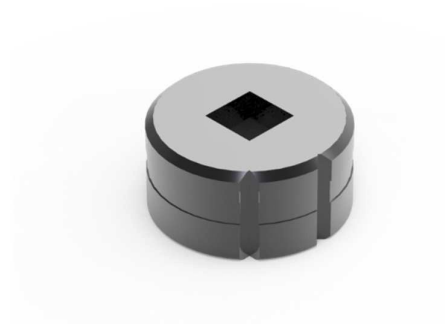

Fritz Haas  
Werksvertretungen  
Robert-Bosch-Str. 6  
90513 Zirndorf

Tel: +49 (0)911 / 699097  
Fax: +49 (0)911 / 697487  
info@haas-werksvertretungen.de

# PEDDINGHAUS

## Langlochmatrize Nr. 2

### Code 50673 2 3

#### Serie A

Artikelnummer	Abmessung	Artikelnummer	Abmessung
5067323001	5.2 x 10.2 mm	5067323108	12.2 x 30.2 mm
5067323005	5.2 x 14.2 mm	5067323105	12.7 x 24.7 mm
5067323007	5.7 x 10.2 mm	5067323115	13.2 x 26.2 mm
5067323003	5.7 x 10.7 mm	5067323117	13.7 x 26.7 mm
5067323013	5.7 x 14.2 mm	5067323167	13.7 x 30.7 mm
5067323006	5.7 x 14.7 mm	5067323127	14.2 x 26.2 mm
5067323014	5.7 x 14.7 mm	5067323129	14.7 x 26.7 mm
5067323017	5.7 x 19.2 mm	5067323131	14.7 x 30.7 mm
5067323021	5.7 x 25.2 mm	5067323139	16.2 x 26.2 mm
5067323011	6.2 x 10.7 mm	5067323141	16.7 x 26.7 mm
5067323015	6.2 x 14.7 mm	5067323143	17.2 x 26.2 mm
5067323019	6.2 x 19.7 mm	5067323145	17.7 x 26.7 mm
5067323023	6.2 x 25.7 mm	5067323147	18.2 x 26.2 mm
5067323025	6.7 x 12.2 mm	5067323149	18.7 x 26.7 mm
5067323029	6.7 x 18.2 mm	5067323151	19.2 x 26.2 mm
5067323033	6.7 x 26.2 mm	5067323153	19.7 x 26.7 mm
5067323027	7.2 x 12.7 mm	5067323163	22.7 x 30.7 mm
5067323031	7.2 x 18.7 mm		
5067323035	7.2 x 26.7 mm		
5067323041	7.7 x 14.2 mm		
5067323042	7.7 x 14.7 mm		
5067323045	7.7 x 21.2 mm		
5067323051	7.7 x 26.2 mm		
5067323043	8.2 x 14.7 mm		
5067323044	8.2 x 16.2 mm		
5067323047	8.2 x 21.7 mm		
5067323053	8.2 x 26.7 mm		
5067323046	8.7 x 16.7 mm		
5067323059	9.2 x 14.2 mm		
5067323063	9.2 x 18.2 mm		
5067323067	9.2 x 26.2 mm		
5067323068	9.2 x 30.2 mm		
5067323061	9.7 x 14.7 mm		
5067323065	9.7 x 18.7 mm		
5067323069	9.7 x 26.7 mm		
5067323071	9.7 x 30.7 mm		
5067323075	10.2 x 14.2 mm		
5067323079	10.2 x 20.2 mm		
5067323083	10.2 x 26.2 mm		
5067323077	10.7 x 14.7 mm		
5067323081	10.7 x 20.7 mm		
5067323085	10.7 x 26.7 mm		
5067323091	11.2 x 22.2 mm		
5067323095	11.2 x 26.2 mm		
5067323099	11.2 x 30.2 mm		
5067323093	11.7 x 22.7 mm		
5067323097	11.7 x 26.7 mm		
5067323101	11.7 x 30.7 mm		
5067323103	12.2 x 24.2 mm		

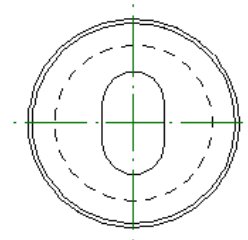
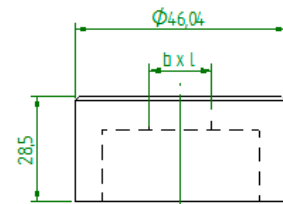

Fritz Haas  
Werkvertretungen  
Robert-Bosch-Str. 6  
90513 Zirndorf

Tel: +49 (0)911 / 699097  
Fax: +49 (0)911 / 697487  
info@haas-werkvertretungen.de

# PEDDINGHAUS

## Rundmatrize Nr. 3

### Code 50673 3 1

#### Serie B

Artikelnummer	Abmessung	Artikelnummer	Abmessung
5067331009	3.2 mm	5067331118	27.7 mm
5067331012	3.7 mm	5067331121	28.2 mm
5067331014	4.2 mm	5067331123	28.7 mm
5067331016	4.7 mm	5067331125	29.2 mm
5067331018	5.2 mm	5067331127	29.7 mm
5067331021	5.7 mm	5067331129	30.2 mm
5067331023	6.2 mm	5067331132	30.7 mm
5067331025	6.7 mm	5067331134	31.2 mm
5067331027	7.2 mm	5067331136	31.7 mm
5067331029	7.7 mm	5067331138	32.2 mm
5067331032	8.2 mm	5067331141	32.7 mm
5067331034	8.7 mm	5067331143	33.2 mm
5067331036	9.2 mm		
5067331038	9.7 mm		
5067331041	10.2 mm		
5067331043	10.7 mm		
5067331045	11.2 mm		
5067331047	11.7 mm		
5067331049	12.2 mm		
5067331052	12.7 mm		
5067331054	13.2 mm		
5067331056	13.7 mm		
5067331058	14.2 mm		
5067331061	14.7 mm		
5067331063	15.2 mm		
5067331065	15.7 mm		
5067331067	16.2 mm		
5067331069	16.7 mm		
5067331072	17.2 mm		
5067331074	17.7 mm		
5067331076	18.2 mm		
5067331078	18.7 mm		
5067331081	19.2 mm		
5067331083	19.7 mm		
5067331085	20.2 mm		
5067331087	20.7 mm		
5067331089	21.2 mm		
5067331092	21.7 mm		
5067331094	22.2 mm		
5067331096	22.7 mm		
5067331098	23.2 mm		
5067331101	23.7 mm		
5067331103	24.2 mm		
5067331105	24.7 mm		
5067331107	25.2 mm		
5067331109	25.7 mm		
5067331112	26.2 mm		
5067331114	26.7 mm		
5067331116	27.2 mm		

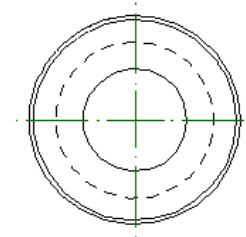
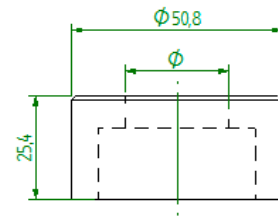

Fritz Haas  
Werksvertretungen  
Robert-Bosch-Str. 6  
90513 Zirndorf

Tel: +49 (0)911 / 699097  
Fax: +49 (0)911 / 697487  
info@haas-werksvertretungen.de

# PEDDINGHAUS

## Vierkantmatrize Nr. 3

### Code 50673 3 2

#### Serie B

Artikelnummer	Abmessung
5067332113	4.2 mm
5067332117	5.2 mm
5067332123	6.2 mm
5067332125	6.7 mm
5067332127	7.2 mm
5067332131	7.7 mm
5067332133	8.2 mm
5067332135	8.7 mm
5067332137	9.2 mm
5067332141	9.7 mm
5067332143	10.2 mm
5067332145	10.7 mm
5067332147	11.2 mm
5067332151	11.7 mm
5067332153	12.2 mm
5067332155	12.7 mm
5067332157	13.2 mm
5067332161	13.7 mm
5067332163	14.2 mm
5067332165	14.7 mm
5067332167	15.2 mm
5067332171	15.7 mm
5067332173	16.2 mm
5067332175	16.7 mm
5067332177	17.2 mm
5067332181	17.7 mm
5067332183	18.2 mm
5067332185	18.7 mm
5067332187	19.2 mm
5067332191	19.7 mm
5067332193	20.2 mm
5067332195	20.7 mm
5067332197	21.2 mm
5067332201	21.7 mm
5067332203	22.2 mm
5067332205	22.7 mm
5067332207	23.2 mm
5067332211	23.7 mm

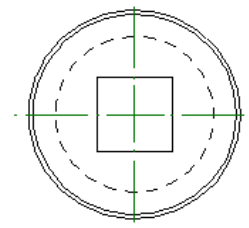
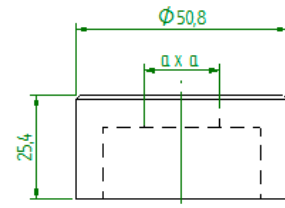
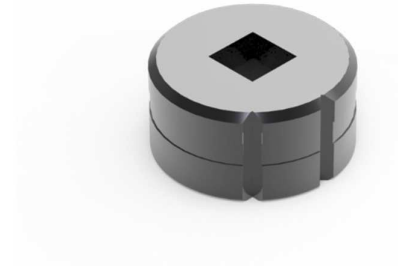

Fritz Haas  
Werksvertretungen  
Robert-Bosch-Str. 6  
90513 Zirndorf

Tel: +49 (0)911 / 699097  
Fax: +49 (0)911 / 697487  
info@haas-werksvertretungen.de



# PEDDINGHAUS

## Langlochmatrize Nr. 3

### Code 50673 3 3

#### Serie B

Artikelnummer	Abmessung	Artikelnummer	Abmessung
5067333001	5.2 x 10.2 mm	5067333100	11.2 x 31.2 mm
5067333005	5.2 x 14.2 mm	5067333221	11.7 x 17.7 mm
5067333007	5.7 x 10.2 mm	5067333093	11.7 x 22.7 mm
5067333003	5.7 x 10.7 mm	5067333223	11.7 x 23.7 mm
5067333013	5.7 x 14.2 mm	5067333097	11.7 x 26.7 mm
5067333006	5.7 x 14.7 mm	5067333101	11.7 x 30.7 mm
5067333014	5.7 x 14.7 mm	5067333102	12.2 x 23.2 mm
5067333017	5.7 x 19.2 mm	5067333103	12.2 x 24.2 mm
5067333021	5.7 x 25.2 mm	5067333104	12.2 x 27.2 mm
5067333011	6.2 x 10.7 mm	5067333107	12.2 x 30.2 mm
5067333015	6.2 x 14.7 mm	5067333106	12.2 x 31.2 mm
5067333019	6.2 x 19.7 mm	5067333105	12.7 x 24.7 mm
5067333023	6.2 x 25.7 mm	5067333109	12.7 x 30.7 mm
5067333025	6.7 x 12.2 mm	5067333110	13.2 x 25.2 mm
5067333029	6.7 x 18.2 mm	5067333115	13.2 x 26.2 mm
5067333033	6.7 x 26.2 mm	5067333119	13.2 x 30.2 mm
5067333037	6.7 x 30.2 mm	5067333120	13.2 x 31.2 mm
5067333027	7.2 x 12.7 mm	5067333231	13.7 x 18.7 mm
5067333031	7.2 x 18.7 mm	5067333233	13.7 x 22.7 mm
5067333035	7.2 x 26.7 mm	5067333117	13.7 x 26.7 mm
5067333039	7.2 x 30.7 mm	5067333235	13.7 x 27.7 mm
5067333201	7.7 x 10.7 mm	5067333121	13.7 x 30.7 mm
5067333041	7.7 x 14.2 mm	5067333237	13.7 x 31.7 mm
5067333203	7.7 x 15.7 mm	5067333127	14.2 x 26.2 mm
5067333205	7.7 x 20.7 mm	5067333126	14.2 x 27.2 mm
5067333045	7.7 x 21.2 mm	5067333131	14.2 x 28.2 mm
5067333051	7.7 x 26.2 mm	5067333128	14.2 x 31.2 mm
5067333055	7.7 x 30.2 mm	5067333129	14.7 x 26.7 mm
5067333043	8.2 x 14.7 mm	5067333133	14.7 x 28.7 mm
5067333047	8.2 x 21.7 mm	5067333333	14.7 x 31.7 mm
5067333053	8.2 x 26.7 mm	5067333135	15.2 x 19.2 mm
5067333057	8.2 x 30.7 mm	5067333134	15.2 x 27.2 mm
5067333059	9.2 x 14.2 mm	5067333241	15.7 x 20.7 mm
5067333063	9.2 x 18.2 mm	5067333243	15.7 x 24.7 mm
5067333067	9.2 x 26.2 mm	5067333245	15.7 x 27.7 mm
5067333071	9.2 x 30.2 mm	5067333139	16.2 x 26.2 mm
5067333211	9.7 x 13.7 mm	5067333143	16.2 x 31.2 mm
5067333061	9.7 x 14.7 mm	5067333141	16.7 x 26.7 mm
5067333065	9.7 x 18.7 mm	5067333145	16.7 x 31.7 mm
5067333213	9.7 x 19.7 mm	5067333252	17.2 x 26.2 mm
5067333215	9.7 x 25.7 mm	5067333146	17.2 x 27.2 mm
5067333069	9.7 x 26.7 mm	5067333148	17.2 x 32.2 mm
5067333073	9.7 x 30.7 mm	5067333251	17.7 x 22.7 mm
5067333075	10.2 x 14.2 mm	5067333253	17.7 x 26.7 mm
5067333079	10.2 x 20.2 mm	5067333147	18.2 x 26.2 mm
5067333083	10.2 x 26.2 mm	5067333151	18.2 x 31.2 mm
5067333087	10.2 x 30.2 mm	5067333149	18.7 x 26.7 mm
5067333077	10.7 x 14.7 mm	5067333153	18.7 x 31.7 mm
5067333081	10.7 x 20.7 mm	5067333156	19.2 x 26.2 mm
5067333085	10.7 x 26.7 mm	5067333154	19.2 x 27.2 mm
5067333089	10.7 x 30.7 mm	5067333155	19.2 x 32.2 mm
5067333090	11.2 x 15.2 mm	5067333261	19.7 x 26.7 mm
5067333092	11.2 x 21.2 mm	5067333159	20.2 x 31.2 mm
5067333091	11.2 x 22.2 mm	5067333161	20.7 x 31.7 mm
5067333095	11.2 x 26.2 mm	5067333162	21.2 x 32.2 mm
5067333096	11.2 x 27.2 mm	5067333163	22.2 x 31.2 mm
5067333099	11.2 x 30.2 mm	5067333165	22.7 x 31.7 mm

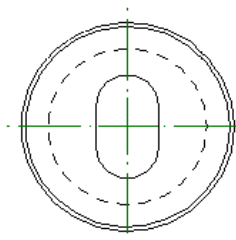
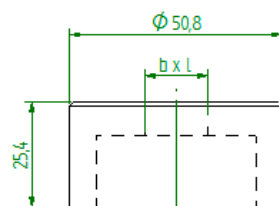

Fritz Haas  
Werksvertretungen  
Robert-Bosch-Str. 6  
90513 Zirndorf  
Tel: +49 (0)911 / 699097  
Fax: +49 (0)911 / 697487  
info@haas-werksvertretungen.de

# PEDDINGHAUS

## Rundmatrize Nr. 4

### Code 50673 4 1

#### Serie C

Artikelnummer	Abmessung	Artikelnummer	Abmessung
5067341018	5.2 mm	5067341127	29.7 mm
5067341021	5.7 mm	5067341129	30.2 mm
5067341023	6.2 mm	5067341132	30.7 mm
5067341025	6.7 mm	5067341134	31.2 mm
5067341027	7.2 mm	5067341136	31.7 mm
5067341029	7.7 mm	5067341138	32.2 mm
5067341032	8.2 mm	5067341141	32.7 mm
5067341034	8.7 mm	5067341143	33.2 mm
5067341036	9.2 mm	5067341145	33.7 mm
5067341038	9.7 mm	5067341147	34.2 mm
5067341041	10.2 mm	5067341149	34.7 mm
5067341043	10.7 mm	5067341152	35.2 mm
5067341045	11.2 mm	5067341154	35.7 mm
5067341047	11.7 mm	5067341156	36.2 mm
5067341049	12.2 mm	5067341158	36.7 mm
5067341052	12.7 mm	5067341161	37.2 mm
5067341054	13.2 mm	5067341163	37.7 mm
5067341056	13.7 mm	5067341165	38.2 mm
5067341058	14.2 mm	5067341167	38.7 mm
5067341061	14.7 mm	5067341169	39.2 mm
5067341063	15.2 mm	5067341172	39.7 mm
5067341065	15.7 mm	5067341174	40.2 mm
5067341067	16.2 mm	5067341176	40.7 mm
5067341069	16.7 mm		
5067341072	17.2 mm		
5067341074	17.7 mm		
5067341076	18.2 mm		
5067341078	18.7 mm		
5067341081	19.2 mm		
5067341083	19.7 mm		
5067341085	20.2 mm		
5067341087	20.7 mm		
5067341089	21.2 mm		
5067341092	21.7 mm		
5067341094	22.2 mm		
5067341096	22.7 mm		
5067341098	23.2 mm		
5067341101	23.7 mm		
5067341103	24.2 mm		
5067341105	24.7 mm		
5067341107	25.2 mm		
5067341109	25.7 mm		
5067341112	26.2 mm		
5067341114	26.7 mm		
506734111	27.2 mm		
5067341118	27.7 mm		
5067341121	28.2 mm		
5067341123	28.7 mm		
5067341125	29.2 mm		

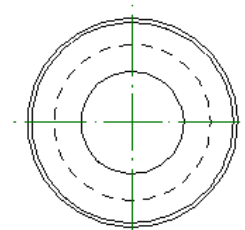
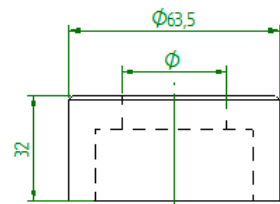

Fritz Haas  
Werkvertretungen  
Robert-Bosch-Str. 6  
90513 Zirndorf

Tel: +49 (0)911 / 699097  
Fax: +49 (0)911 / 697487  
info@haas-werkvertretungen.de

# PEDDINGHAUS

## Vierkantmatrize Nr. 4

Code 50673 4 2

### Serie C

Artikelnummer	Abmessung
5067342181	17.7 mm
5067342183	18.2 mm
5067342185	18.7 mm
5067342187	19.2 mm
5067342191	19.7 mm
5067342193	20.2 mm
5067342195	20.7 mm
5067342197	21.2 mm
5067342201	21.7 mm
5067342203	22.2 mm
5067342205	22.7 mm
5067342207	23.2 mm
5067342211	23.7 mm
5067342213	24.2 mm
5067342215	24.7 mm
5067342217	25.2 mm
5067342221	25.7 mm
5067342223	26.2 mm
5067342225	26.7 mm
5067342227	27.2 mm
5067342231	27.7 mm
5067342233	28.2 mm
5067342235	28.7 mm

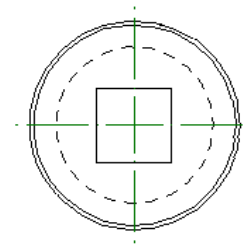
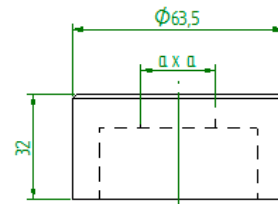
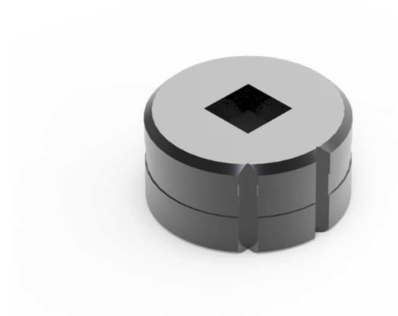

Fritz Haas  
Werksvertretungen  
Robert-Bosch-Str. 6  
90513 Zirndorf

Tel: +49 (0)911 / 699097  
Fax: +49 (0)911 / 697487  
info@haas-werksvertretungen.de

# PEDDINGHAUS

## Langlochmatrize Nr. 4

Code 50673 4 3

### Serie C

Artikelnummer	Abmessung	Artikelnummer	Abmessung
5067343001	5.2 x 10.2 mm	5067343107	12.2 x 30.2 mm
5067343005	5.2 x 14.2 mm	5067343111	12.2 x 35.2 mm
5067343007	5.7 x 10.2 mm	5067343105	12.7 x 24.7 mm
5067343003	5.7 x 10.7 mm	5067343109	12.7 x 30.7 mm
5067343013	5.7 x 14.2 mm	5067343113	12.7 x 35.7 mm
5067343006	5.7 x 14.7 mm	5067343114	12.7 x 40.7 mm
5067343017	5.7 x 19.2 mm	5067343115	13.2 x 26.2 mm
5067343021	5.7 x 25.2 mm	5067343119	13.2 x 30.2 mm
5067343011	6.2 x 10.7 mm	5067343123	13.2 x 35.2 mm
5067343015	6.2 x 14.7 mm	5067343124	13.2 x 40.2 mm
5067343019	6.2 x 19.7 mm	5067343117	13.7 x 26.7 mm
5067343023	6.2 x 25.7 mm	5067343121	13.7 x 30.7 mm
5067343025	6.7 x 12.2 mm	5067343125	13.7 x 35.7 mm
5067343029	6.7 x 18.2 mm	5067343126	13.7 x 40.7 mm
5067343033	6.7 x 26.2 mm	5067343127	14.2 x 26.2 mm
5067343037	6.7 x 30.2 mm	5067343131	14.2 x 28.2 mm
5067343027	7.2 x 12.7 mm	5067343135	14.2 x 35.2 mm
5067343031	7.2 x 18.7 mm	5067343129	14.7 x 26.7 mm
5067343035	7.2 x 26.7 mm	5067343133	14.7 x 28.7 mm
5067343039	7.2 x 30.7 mm	5067343137	14.7 x 35.7 mm
5067343041	7.7 x 14.2 mm	5067343138	14.7 x 40.7 mm
5067343045	7.7 x 21.2 mm	5067343139	16.2 x 26.2 mm
5067343051	7.7 x 26.2 mm	5067343143	16.2 x 31.2 mm
5067343055	7.7 x 30.2 mm	5067343141	16.7 x 26.7 mm
5067343043	8.2 x 14.7 mm	5067343145	16.7 x 31.7 mm
5067343063	8.2 x 18.2 mm	5067343146	16.7 x 40.7 mm
5067343047	8.2 x 21.7 mm	5067343155	18.2 x 36.2 mm
5067343053	8.2 x 26.7 mm	5067343147	18.2 x 26.2 mm
5067343057	8.2 x 30.7 mm	5067343151	18.2 x 31.2 mm
5067343059	9.2 x 14.2 mm	5067343149	18.7 x 26.7 mm
5067343067	9.2 x 26.2 mm	5067343153	18.7 x 31.7 mm
5067343071	9.2 x 30.2 mm	5067343157	18.7 x 36.7 mm
5067343061	9.7 x 14.7 mm	5067343158	18.7 x 40.7 mm
5067343065	9.7 x 18.7 mm	5067343159	20.2 x 31.2 mm
5067343069	9.7 x 26.7 mm	5067343161	20.7 x 31.7 mm
5067343073	9.7 x 30.7 mm	5067343163	22.2 x 31.2 mm
5067343075	10.2 x 14.0 mm	5067343165	22.7 x 31.7 mm
5067343079	10.2 x 20.2 mm		
5067343083	10.2 x 26.2 mm		
5067343087	10.2 x 30.2 mm		
5067343077	10.7 x 14.7 mm		
5067343081	10.7 x 20.7 mm		
5067343085	10.7 x 26.7 mm		
5067343089	10.7 x 30.7 mm		
5067343091	11.2 x 22.2 mm		
5067343095	11.2 x 26.2 mm		
5067343099	11.2 x 30.2 mm		
5067343102	11.2 x 40.2 mm		
5067343093	11.7 x 22.7 mm		
5067343097	11.7 x 26.7 mm		
5067343101	11.7 x 30.7 mm		
5067343202	11.7 x 40.7 mm		
5067343103	12.2 x 24.2 mm		

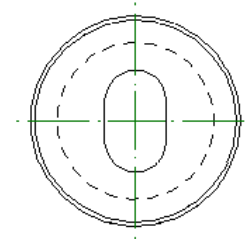
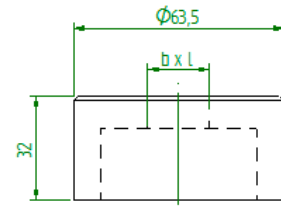

Fritz Haas  
Werkvertretungen  
Robert-Bosch-Str. 6  
90513 Zirndorf

Tel: +49 (0)911 / 699097  
Fax: +49 (0)911 / 697487  
info@haas-werkvertretungen.de

# PEDDINGHAUS

## Rundmatrize Nr. 6

### Code 50673 6 1

#### Serie C

Artikelnummer	Abmessung
5067361174	40.2 mm
5067361176	40.7 mm
5067361178	41.2 mm
5067361181	41.7 mm
5067361183	42.2 mm
5067361185	42.7 mm
5067361187	43.2 mm
5067361189	43.7 mm
5067361192	44.2 mm
5067361194	44.7 mm
5067361196	45.2 mm
5067361198	45.7 mm
5067361201	46.2 mm
5067361203	46.7 mm
5067361205	47.2 mm
5067361207	47.7 mm
5067361209	48.2 mm
5067361212	48.7 mm
5067361214	49.2 mm
5067361216	49.7 mm
5067361218	50.2 mm
5067361221	50.7 mm
5067361223	51.2 mm
5067361225	51.7 mm
5067361227	52.2 mm
5067361229	52.7 mm
5067361232	53.2 mm
5067361234	53.7 mm
5067361236	54.2 mm
5067361238	54.7 mm
5067361241	55.2 mm
5067361243	55.7 mm
5067361245	56.2 mm
5067361247	56.7 mm
5067361249	57.2 mm
5067361252	57.7 mm
5067361254	58.2 mm
5067361256	58.7 mm
5067361258	59.2 mm
5067361261	59.7 mm
5067361263	60.2 mm
5067361265	60.7 mm
5067361267	61.2 mm
5067361269	61.7 mm
5067361272	62.2 mm
5067361274	62.7 mm
5067361276	63.2 mm
5067361278	63.7 mm
5067361281	64.2 mm
5067361283	64.7 mm
5067361285	65.2 mm
5067361287	65.7 mm

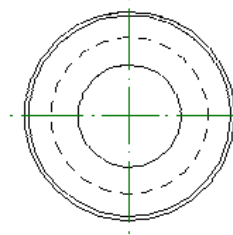
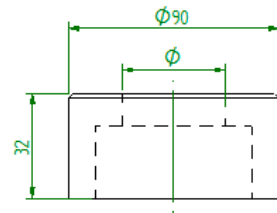

Fritz Haas  
Werksvertretungen  
Robert-Bosch-Str. 6  
90513 Zirndorf

Tel: +49 (0)911 / 699097  
Fax: +49 (0)911 / 697487  
info@haas-werksvertretungen.de

# PEDDINGHAUS

## Vierkantmatrize Nr. 6

Code 50673 6 2

### Serie C

Artikelnummer	Abmessung
5067362243	30.2 mm
5067362245	30.7 mm
5067362267	35.2 mm
5067362269	35.7 mm
5067362303	40.2 mm
5067362305	40.7 mm

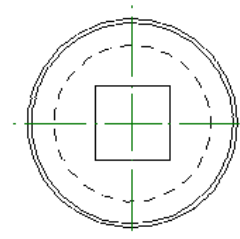
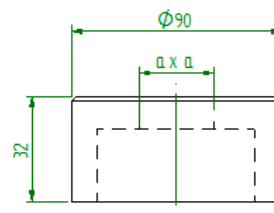
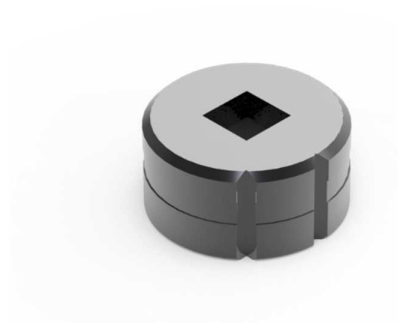

Fritz Haas  
Werksvertretungen  
Robert-Bosch-Str. 6  
90513 Zirndorf

Tel: +49 (0)911 / 699097  
Fax: +49 (0)911 / 697487  
info@haas-werksvertretungen.de

# PEDDINGHAUS

## Langlochmatrize Nr. 6

Code 50673 6 3

### Serie C

Artikelnummer	Abmessung
5067363171	11.2 x 40.2 mm
5067363172	11.7 x 40.7 mm
5067363173	12.2 x 40.2 mm
5067363174	12.7 x 40.7 mm
5067363175	13.2 x 40.2 mm
5067363176	13.7 x 40.7 mm
5067363177	14.2 x 40.2 mm
5067363178	14.7 x 40.7 mm
5067363179	16.2 x 40.2 mm
5067363181	16.2 x 55.2 mm
5067363180	16.7 x 40.7 mm
5067363182	16.7 x 55.7 mm
5067363183	18.2 x 40.2 mm
5067363185	18.2 x 55.2 mm
5067363184	18.7 x 40.7 mm
5067363186	18.7 x 55.7 mm
5067363187	20.2 x 40.2 mm
5067363189	20.2 x 55.2 mm
5067363188	20.7 x 40.7 mm
5067363190	20.7 x 55.7 mm
5067363191	22.2 x 40.2 mm
5067363201	22.2 x 44.2 mm
5067363193	22.2 x 55.2 mm
5067363192	22.7 x 40.7 mm
5067363205	22.7 x 44.7 mm
5067363195	22.7 x 55.7 mm

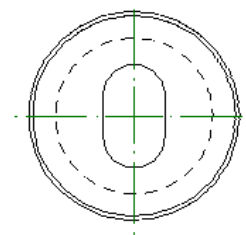
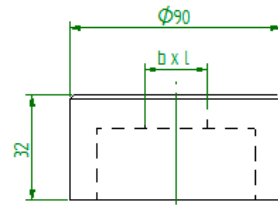

Fritz Haas  
Werksvertretungen  
Robert-Bosch-Str. 6  
90513 Zirndorf

Tel: +49 (0)911 / 699097  
Fax: +49 (0)911 / 697487  
info@haas-werksvertretungen.de

# PEDDINGHAUS

## Rundmatrize Nr. 13

### Code 50674 1 3

#### Serie A

Artikelnummer	Abmessung
5067413009	3.2 mm
5067413012	3.7 mm
5067413014	4.2 mm
5067413016	4.7 mm
5067413018	5.2 mm
5067413021	5.7 mm
5067413023	6.2 mm
5067413025	6.7 mm
5067413027	7.2 mm
5067413029	7.7 mm
5067413032	8.2 mm
5067413034	8.7 mm
5067413036	9.2 mm
5067413038	9.7 mm
5067413041	10.2 mm
5067413043	10.7 mm
5067413045	11.2 mm
5067413047	11.7 mm
5067413049	12.2 mm
5067413052	12.7 mm
5067413054	13.2 mm
5067413056	13.7 mm
5067413058	14.2 mm
5067413061	14.7 mm
5067413063	15.2 mm
5067413065	15.7 mm
5067413067	16.2 mm
5067413069	16.7 mm
5067413072	17.2 mm
5067413074	17.7 mm
5067413076	18.2 mm
5067413078	18.7 mm
5067413081	19.2 mm
5067413083	19.7 mm
5067413085	20.2 mm
5067413087	20.7 mm
5067413089	21.2 mm
5067413092	21.7 mm
5067413094	22.2 mm
5067413096	22.7 mm

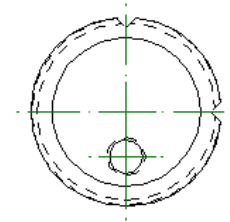
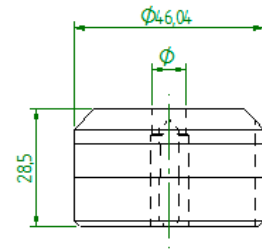

Fritz Haas  
Werksvertretungen  
Robert-Bosch-Str. 6  
90513 Zirndorf

Tel: +49 (0)911 / 699097  
Fax: +49 (0)911 / 697487  
info@haas-werksvertretungen.de



# PEDDINGHAUS

## Rundmatrize Nr. 14

### Code 50674 1 4

#### Serie B

Artikelnummer	Abmessung
5067414009	3.2 mm
5067414012	3.7 mm
5067414014	4.2 mm
5067414016	4.7 mm
5067414018	5.2 mm
5067414021	5.7 mm
5067414023	6.2 mm
5067414025	6.7 mm
5067414027	7.2 mm
5067414029	7.7 mm
5067414032	8.2 mm
5067414034	8.7 mm
5067414036	9.2 mm
5067414038	9.7 mm
5067414041	10.2 mm
5067414043	10.7 mm
5067414045	11.2 mm
5067414047	11.7 mm
5067414049	12.2 mm
5067414052	12.7 mm
5067414054	13.2 mm
5067414056	13.7 mm
5067414058	14.2 mm
5067414061	14.7 mm
5067414063	15.2 mm
5067414065	15.7 mm
5067414067	16.2 mm
5067414069	16.7 mm
5067414072	17.2 mm
5067414074	17.7 mm
5067414076	18.2 mm
5067414078	18.7 mm
5067414081	19.2 mm
5067414083	19.7 mm
5067414085	20.2 mm
5067414087	20.7 mm
5067414089	21.2 mm
5067414092	21.7 mm
5067414094	22.2 mm
5067414096	22.7 mm
5067414098	23.2 mm
5067414101	23.7 mm
5067414103	24.2 mm
5067414105	24.7 mm

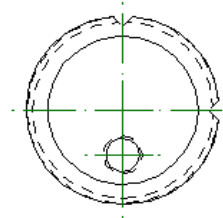
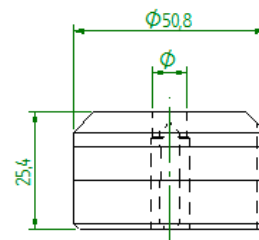

Fritz Haas

Werkvertretungen  
Robert-Bosch-Str. 6  
90513 Zirndorf

Tel: +49 (0)911 / 699097  
Fax: +49 (0)911 / 697487  
info@haas-werkvertretungen.de

# PEDDINGHAUS

## Rundmatrize Nr. 20

Code 50673 7 1

### Serie C

Artikelnummer	Abmessung
5067371312	70.2 mm
5067371314	70.7 mm
5067371334	75.2 mm
5067371336	75.7 mm
5067371356	80.2 mm
5067371358	80.7 mm
5067371378	85.2 mm
5067371381	85.7 mm
5067371401	85.7 mm
5067371403	90.7 mm
5067371423	95.2 mm
5067371425	95.7 mm
5067371444	100.2 mm
5067371445	100.7 mm

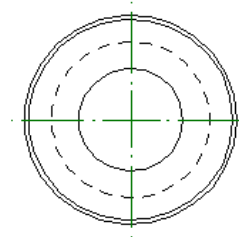
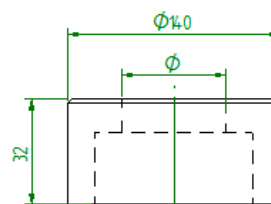

Fritz Haas  
Werksvertretungen  
Robert-Bosch-Str. 6  
90513 Zirndorf

Tel: +49 (0)911 / 699097  
Fax: +49 (0)911 / 697487  
info@haas-werksvertretungen.de

# PEDDINGHAUS

## Exzentermatrize Nr. 13 - längs

Code 50674 3 3

### Serie A

Artikelnummer	Abmessung
5067433015	6.2 x 14.7 mm
5067433023	6.2 x 25.7 mm
5067433035	7.2 x 26.7 mm
5067433053	8.2 x 26.7 mm
5067433061	8.2 x 14.7 mm
5067433069	9.7 x 26.7 mm
5067433081	10.7 x 20.7 mm
5067433093	11.7 x 22.7 mm
5067433097	11.7 x 26.7 mm
5067433113	13.7 x 26.7 mm
5067433121	14.7 x 26.7 mm
5067433129	16.7 x 26.7 mm

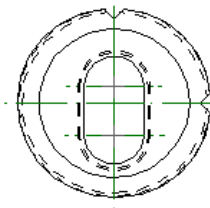
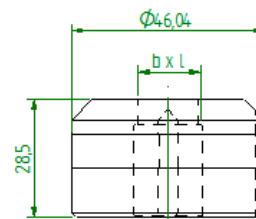

Fritz Haas  
Werksvertretungen  
Robert-Bosch-Str. 6  
90513 Zirndorf

Tel: +49 (0)911 / 699097  
Fax: +49 (0)911 / 697487  
info@haas-werksvertretungen.de

# PEDDINGHAUS

## Exzentermatrize Nr. 13 - quer

Code 50674 4 3

### Serie A

Artikelnummer	Abmessung
5067443015	6.2 x 14.7 mm
5067443023	6.2 x 25.7 mm
5067443035	7.2 x 26.7 mm
5067443053	8.2 x 26.7 mm
5067443061	9.7 x 14.7 mm
5067443069	9.7 x 26.7 mm
5067443081	10.7 x 20.7 mm
5067443093	11.7 x 22.7 mm
5067443097	11.7 x 26.7 mm
5067443113	13.7 x 26.7 mm
5067443121	14.7 x 26.7 mm
5067443129	16.7 x 26.7 mm

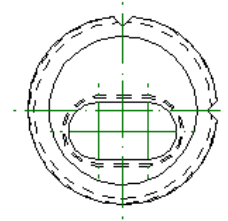
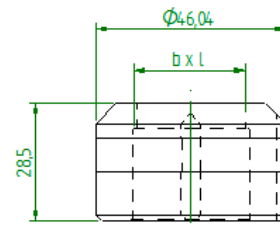

Fritz Haas  
Werksvertretungen  
Robert-Bosch-Str. 6  
90513 Zirndorf

Tel: +49 (0)911 / 699097  
Fax: +49 (0)911 / 697487  
info@haas-werksvertretungen.de

# PEDDINGHAUS

## Exzentermatrize Nr. 14 - längs

Code 50674 3 4

### Serie B

Artikelnummer	Abmessung
5067434015	6.2 x 14.7 mm
5067434023	6.2 x 25.7 mm
5067434035	7.2 x 26.7 mm
5067434053	8.2 x 26.7 mm
5067434061	9.7 x 14.7 mm
5067434069	9.7 x 26.7 mm
5067434081	10.7 x 20.7 mm
5067434093	11.7 x 22.7 mm
5067434097	11.7 x 26.7 mm
5067434113	13.7 x 26.7 mm
5067434121	14.7 x 26.7 mm
5067434129	16.7 x 26.7 mm

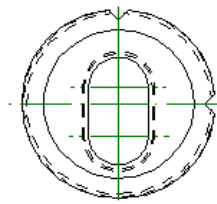
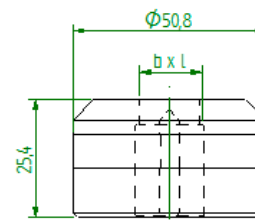

Fritz Haas  
Werksvertretungen  
Robert-Bosch-Str. 6  
90513 Zirndorf

Tel: +49 (0)911 / 699097  
Fax: +49 (0)911 / 697487  
info@haas-werksvertretungen.de

# PEDDINGHAUS

## Exzentermatrize Nr. 14 - quer

Code 50674 4 4

### Serie B

Artikelnummer	Abmessung
5067444015	6.2 x 14.7 mm
5067444023	6.2 x 25.7 mm
5067444035	7.2 x 26.7 mm
5067444053	8.2 x 26.7 mm
5067444061	9.7 x 14.7 mm
5067444069	9.7 x 26.7 mm
5067444081	10.7 x 20.7 mm
5067444093	11.7 x 22.7 mm
5067444097	11.7 x 26.7 mm
5067444113	13.7 x 26.7 mm
5067444121	14.7 x 26.7 mm
5067444129	16.7 x 26.7 mm
5067444062	9.7 x 18.7 mm
5067444099	12.2 x 24.2 mm
5067444098	12.7 x 24.7 mm
5067444120	14.2 x 26.2 mm

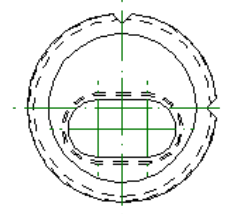
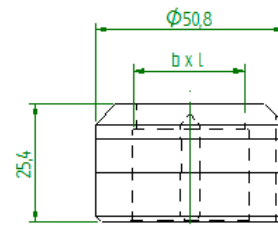
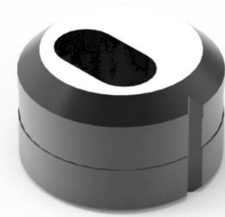

Fritz Haas  
Werksvertretungen  
Robert-Bosch-Str. 6  
90513 Zirndorf

Tel: +49 (0)911 / 699097  
Fax: +49 (0)911 / 697487  
info@haas-werksvertretungen.de

# PEDDINGHAUS

## Werkzeuge zum Stanzen von Löchern für Profilylinder

Artikelnummer	Bezeichnung
5055644000	PFP Profilylinderstempel Nr. 4
5055654000	PFP Profilylinderstempel Nr. 5
5055664000	PFP Profilylinderstempel Nr. 6
5067324000	PFP Profilylindermatrize Nr. 2
5067334000	PFP Profilylindermatrize Nr. 3
5067344000	PFP Profilylindermatrize Nr. 4

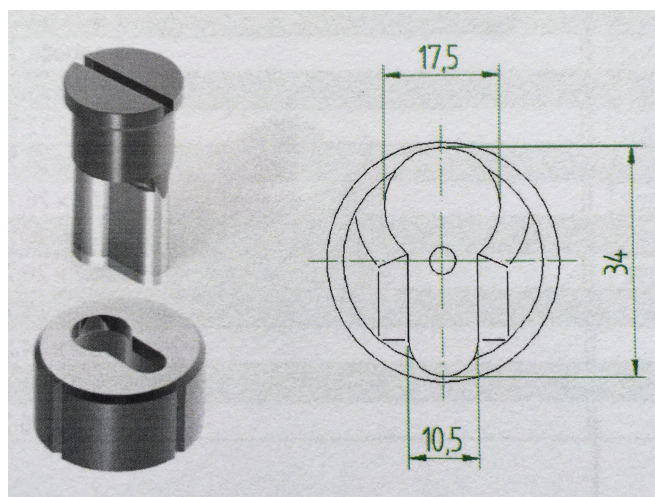

## Werkzeuge zum Abrunden von Ecken (90°) für Flachmaterial

Artikelnummer	Bezeichnung	Abmessung
5055635005	PFP Eckenabrundstempel Nr. 3	R 5 mm
5055635010	PFP Eckenabrundstempel Nr. 3	R 10 mm
5055635014	PFP Eckenabrundstempel Nr. 3	R 14 mm
5055645005	PFP Eckenabrundstempel Nr. 4	R 5 mm
5055645010	PFP Eckenabrundstempel Nr. 4	R 10 mm
5055645014	PFP Eckenabrundstempel Nr. 4	R 14 mm
5055645015	PFP Eckenabrundstempel Nr. 4	R 15 mm
5055655005	PFP Eckenabrundstempel Nr. 5	R 5 mm
5055655010	PFP Eckenabrundstempel Nr. 5	R 10 mm
5055655015	PFP Eckenabrundstempel Nr. 5	R 15 mm
5055665015	PFP Eckenabrundstempel Nr. 6	R 15 mm
5055665020	PFP Eckenabrundstempel Nr. 6	R 20 mm
5055675025	PFP Eckenabrundstempel Nr. 7	R 25 mm
5055675030	PFP Eckenabrundstempel Nr. 7	R 30 mm
5055675035	PFP Eckenabrundstempel Nr. 7	R 35 mm
5067325005	PFP Eckenabrundmatrize Nr. 2	R 5 mm
5067325010	PFP Eckenabrundmatrize Nr. 2	R 10 mm
5067325014	PFP Eckenabrundmatrize Nr. 2	R 14 mm
5067325015	PFP Eckenabrundmatrize Nr. 2	R 15 mm
5067335005	PFP Eckenabrundmatrize Nr. 3	R 5 mm
5067335010	PFP Eckenabrundmatrize Nr. 3	R 10 mm
5067335014	PFP Eckenabrundmatrize Nr. 3	R 14 mm
5067335015	PFP Eckenabrundmatrize Nr. 3	R 15 mm
5067345015	PFP Eckenabrundmatrize Nr. 4	R 15 mm
5067345020	PFP Eckenabrundmatrize Nr. 4	R 20 mm
5067365025	PFP Eckenabrundmatrize Nr. 6	R 25 mm
5067365030	PFP Eckenabrundmatrize Nr. 6	R 30 mm
5067365035	PFP Eckenabrundmatrize Nr. 6	R 35 mm



Fritz Haas  
 Werksvertretungen  
 Robert-Bosch-Str. 6  
 90513 Zirndorf

Tel: +49 (0)911 / 699097  
 Fax: +49 (0)911 / 697487  
 info@haas-werksvertretungen.de

# PEDDINGHAUS

## Werkzeuge zum Trennen und Abrunden (eine Seite gerade / eine abgerundet)

Werkzeugtyp	Flachstahl / Radius
PFP Trenn- und Abrundstempel Nr. 7	E = 30 x 8 / 20
PFP Trenn- und Abrundstempel Nr. 7	E = 40 x 8 / 25
PFP Trenn- und Abrundmatrize Nr. 6	E = 30 x 8 / 20
PFP Trenn- und Abrundmatrize Nr. 6	E = 40 x 8 / 25

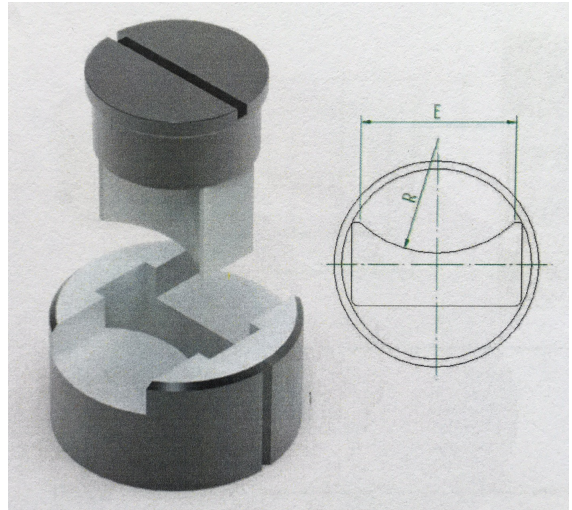

## Werkzeuge zum Trennen und gleichzeitigen Abrunden

Werkzeugtyp	Flachstahl / Radius
PFP Trenn- und Doppelabrundstempel Nr. 7	E = 30 x 8 / 20
PFP Trenn- und Doppelabrundstempel Nr. 7	E = 40 x 8 / 25
PFP Trenn- und Doppelabrundmatrize Nr. 6	E = 30 x 8 / 20
PFP Trenn- und Doppelabrundmatrize Nr. 6	E = 40 x 8 / 25

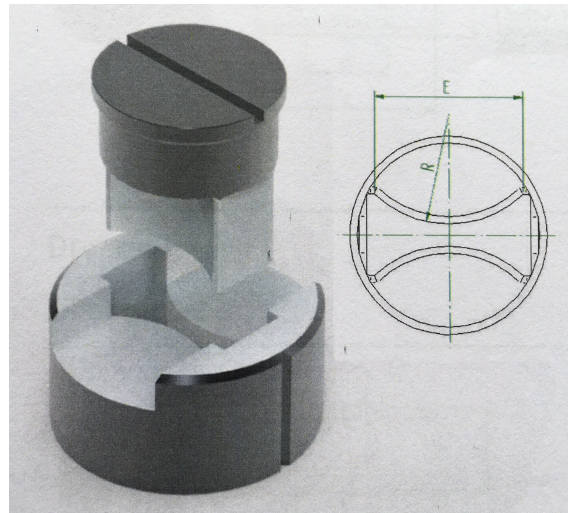

Fritz Haas  
Werksvertretungen  
Robert-Bosch-Str. 6  
90513 Zirndorf

Tel: +49 (0)911 / 699097  
Fax: +49 (0)911 / 697487  
info@haas-werksvertretungen.de



## Kapitel 2

Stempel- / Matrizenreduzierungen  
Druckstücke

Fritz Haas  
Werksvertretungen  
Robert-Bosch-Str. 6  
90513 Zirndorf

Tel: +49 (0)911 / 699097  
Fax: +49 (0)911 / 697487  
[info@haas-werksvertretungen.de](mailto:info@haas-werksvertretungen.de)

# PEDDINGHAUS

## Reduzierhülsen

Artikelnummer	Abmessung			Typ	PFP Artikelnummer
	d	D	H		
5055901000	14,5	26,4	24,5	Nr. 1 / Nr. 4	44001198503
5055902000	19,4	31,0	22,0	Nr. 2 / Nr. 5	44081198503
5055902500	26,5	39,5	29,0	Nr. 4 / Nr. 5	
5055903000	26,5	58,5	23,0	Nr. 3 / Nr. 6	44161198503
5055904000	39,7	58,5	23,0	Nr. 3 / Nr. 7	44001198813
5055905000	26,5	90,0	23,0	Nr. 6 / Nr. 7	44001198814
5055906000	39,7	90,0	23,0	Nr. 3 / Nr. 11	440011988333
5055907000	58,7	90,0	23,0	Nr. 6 / Nr. 11	440011988332

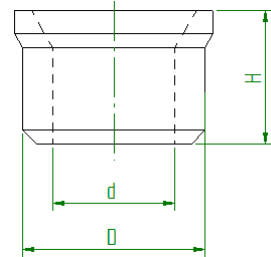

## Reduzierhülsen

Artikelnummer	Abmessung				Typ	PFP Artikelnummer
	d1	d2	D	H		
5055909000	40,0	26,6	58,5	38,0	Nr. 4 / Nr. 7	440011988133
5055910000	40,0	31,7	58,5	25,0	Nr. 5 / Nr. 7	407785680701
5055911000	40,0	26,6	90,0	38,0	Nr. 4 / Nr. 11	440011988334
5055912000	40,0	31,7	90,0	25,0	Nr. 5 / Nr. 11	440811988331

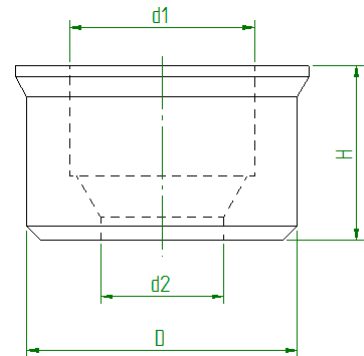

## Druckstücke

Artikelnummer	Abm.		Typ	PFP Artikelnummer
	D	H		
5053201000	39	22	4 / 7 + 11	440011988143
5053202000	39	15	5 / 7 + 11	407785680702

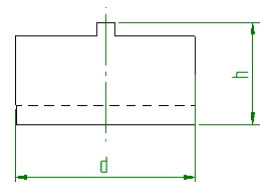

Fritz Haas  
Werkvertretungen  
Robert-Bosch-Str. 6  
90513 Zirndorf

Tel: +49 (0)911 / 699097  
Fax: +49 (0)911 / 697487  
info@haas-werkvertretungen.de



Bitte kreuzen Sie an:

Anfrage:

Bestellung:

Sie hören in Kürze von uns!

Stückzahl	Referenz-/Artikelnummer	Artikelbezeichnung	Artikelabmessung

Firmenanschrift / zuständig ist:

Rückfax an 0911 / 697487 !!!

---



---



---



---



---